

Alienware M14xR2 Owner's Manual

Regulatory model: P18G

Regulatory type: P18G002



Notes, Cautions, and Warnings



NOTE: A NOTE indicates important information that helps you make better use of your computer.



CAUTION: A CAUTION indicates potential damage to hardware or loss of data if instructions are not followed.



WARNING: A WARNING indicates a potential for property damage, personal injury, or death.

Information in this document is subject to change without notice.

© 2012 Dell Inc. All rights reserved.

Reproduction of these materials in any manner whatsoever without the written permission of Dell Inc. is strictly forbidden.

Trademarks used in this text: Dell™ and the DELL logo are trademarks of Dell Inc.; Alienware® is a trademark or registered trademark of Alienware Corporation; Microsoft®, Windows®, and the Windows start button logo are either trademarks or registered trademarks of Microsoft Corporation in the United States and/or other countries; Bluetooth® is a registered trademark owned by Bluetooth SIG, Inc. and is used by Dell under license.

Other trademarks and trade names may be used in this document to refer to either the entities claiming the marks and names or their products. Dell Inc. disclaims any proprietary interest in trademarks and trade names other than its own.

Regulatory model: P18G

Regulatory type: P18G002

2012 - 04

Rev. A00

Contents

1	Before You Begin	11
	Turn Off Your Computer and Connected Devices	11
	Safety Instructions.	12
	Recommended Tools.	12
2	After Working Inside Your Computer.	13
3	Base Cover	15
	Removing the Base Cover	15
	Replacing the Base Cover	16
4	Battery	17
	Removing the Battery	17
	Replacing the Battery	18
5	Optical Drive	19
	Removing the Optical Drive	19
	Replacing the Optical Drive	22

6	Hard Drive	25
	Removing the Hard Drive	25
	Replacing the Hard Drive	27
7	Memory Module(s).	29
	Removing the Memory Module(s)	29
	Replacing the Memory Module(s)	31
8	Center-Control Cover.	33
	Removing the Center-Control Cover	33
	Replacing the Center-Control Cover	35
9	Keyboard	37
	Removing the Keyboard	37
	Replacing the Keyboard	39
10	Palm-Rest Assembly	41
	Removing the Palm-Rest Assembly	41
	Replacing the Palm-Rest Assembly	44

11	Wireless Mini-Card(s)/WirelessHD Card (Optional)	45
	Removing the Mini-Card(s)	45
	Replacing the Mini-Card(s)	47
12	Power-Button Board	49
	Removing the Power-Button Board	49
	Replacing the Power-Button Board	50
13	Status-Lights Board	53
	Removing the Status-Lights Board	53
	Replacing the Status-Lights Board	55
14	Speakers	57
	Removing the Speakers	57
	Replacing the Speakers	58
15	Subwoofer	61
	Removing the Subwoofer	61
	Replacing the Subwoofer	62

16	Internal Card with Bluetooth Wireless Technology	65
	Removing the Bluetooth Card	65
	Replacing the Bluetooth Card	66
17	Coin-Cell Battery	69
	Removing the Coin-Cell Battery	69
	Replacing the Coin-Cell Battery	70
18	Display Assembly	73
	Removing the Display Assembly	73
	Replacing the Display Assembly	76
19	Mini-Card Board	77
	Removing the Mini-Card Board	77
	Replacing the Mini-Card Board	78
20	System Board	81
	Removing the System Board	81
	Replacing the System Board	84
	Entering the Service Tag in the BIOS	85

21 Thermal Fan	87
Removing the Thermal Fan	87
Replacing the Thermal Fan	88
22 Thermal Cooling Assembly	89
Removing the Thermal Cooling Assembly	89
Replacing the Thermal Cooling Assembly	90
23 Processor Module	93
Removing the Processor Module	93
Replacing the Processor Module	95
24 System Setup	97
Overview	97
Entering System Setup	97
25 Flashing the BIOS	105

Before You Begin

Turn Off Your Computer and Connected Devices

 **CAUTION:** To avoid losing data, save and close all open files and exit all open programs before you turn off your computer.

- 1 Save and close all open files and exit all open programs.
- 2 Click Start  and click Shut Down.









Microsoft Windows shuts down and then the computer turns off.

 **NOTE:** If you are using a different operating system, see the documentation of your operating system for shut-down instructions.

- 3 Disconnect your computer and all attached devices from their electrical outlets.
- 4 Disconnect all telephone cables, network cables, and attached devices from your computer.
- 5 After the computer is unplugged, press and hold the power button for about 5 seconds to ground the system board.

Safety Instructions

Use the following safety guidelines to protect your computer from potential damage and ensure your personal safety.

-  **WARNING:** Before working inside your computer, read the safety information that shipped with your computer. For additional safety best practices information, see the Regulatory Compliance Homepage at dell.com/regulatory_compliance.
-  **CAUTION:** To avoid damaging the computer, ensure that the work surface is flat and clean.
-  **CAUTION:** To avoid damaging the components and cards, handle them by their edges and avoid touching pins and contacts.
-  **WARNING:** Disconnect all power sources before opening the computer cover or panels. After you finish working inside the computer, replace all covers, panels, and screws before connecting to the power source.
-  **CAUTION:** Only a certified service technician is authorized to remove the computer cover and access any of the components inside the computer. See the safety instructions for complete information about safety precautions, working inside your computer, and protecting against electrostatic discharge.
-  **CAUTION:** Before touching anything inside your computer, ground yourself by touching an unpainted metal surface, such as the metal at the back of the computer. While you work, periodically touch an unpainted metal surface to dissipate static electricity, which could harm internal components.
-  **CAUTION:** When you disconnect a cable, pull on its connector or on its pull-tab, not on the cable itself. Some cables have connectors with locking tabs or thumb-screws that you must disengage before disconnecting the cable. When disconnecting cables, keep them evenly aligned to avoid bending any connector pins. When connecting cables, ensure that the connectors and ports are correctly oriented and aligned.
-  **CAUTION:** To disconnect a network cable, first unplug the cable from your computer and then unplug the cable from the network device.

Recommended Tools

The procedures in this document may require the following tools:

- Small flat-blade screwdriver
- Phillips screwdriver
- Plastic scribe

After Working Inside Your Computer

After you complete the replacement procedures, ensure the following:

- Replace all screws and ensure that no stray screws remain inside your computer
- Connect any external devices, cables, cards, and any other part(s) you removed before working on your computer
- Connect your computer and all attached devices to their electrical outlets



CAUTION: Before turning on your computer, replace all screws and ensure that no stray screws remain inside the computer. Failure to do so may damage your computer.

Base Cover

⚠ WARNING: Before working inside your computer, read the safety information that shipped with your computer and follow the steps in "Before You Begin" on page 11. For additional safety best practices information, see the Regulatory Compliance Homepage at dell.com/regulatory_compliance.

Removing the Base Cover

Procedure

- 1 Turn the computer over.
- 2 Loosen the captive screws that secure the base cover to the computer base.
- 3 Slide and lift the base cover off the computer base.



- 1 captive screws (2) 2 base cover

Replacing the Base Cover

Procedure

- 1 Align the tabs on the base cover with the slots on the computer base and slide the base cover until it snaps into place.
- 2 Tighten the captive screws that secure the base cover to the computer base.

Postrequisites

- 1 Follow the instructions in "After Working Inside Your Computer" on page 13.

Battery

 **WARNING:** Before working inside your computer, read the safety information that shipped with your computer and follow the steps in "Before You Begin" on page 11. For additional safety best practices information, see the Regulatory Compliance Homepage at dell.com/regulatory_compliance.

Removing the Battery

Prerequisites

- 1 Remove the base cover. See "Removing the Base Cover" on page 15.

Procedure

- 1 Disconnect the battery cable from the connector on the system board.
- 2 Loosen the captive screws that secure the battery to the computer base.

- 3 Using the pull-tab, lift the battery off the computer base.

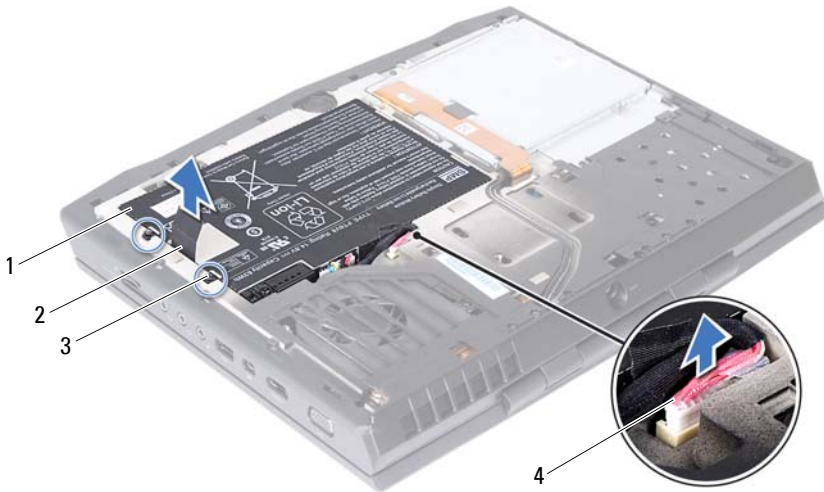

- | | | | |
|---|--------------------|---|---------------|
| 1 | battery | 2 | pull-tab |
| 3 | captive screws (2) | 4 | battery cable |

Replacing the Battery

Procedure

- 1 Place the battery in the battery bay and tighten the captive screws that secure the battery to the computer base.
- 2 Connect the battery cable to the connector on the system board.

Postrequisites

- 1 Replace the base cover. See "Replacing the Base Cover" on page 16.
- 2 Follow the instructions in "After Working Inside Your Computer" on page 13.

Optical Drive

 **WARNING:** Before working inside your computer, read the safety information that shipped with your computer and follow the steps in "Before You Begin" on page 11. For additional safety best practices information, see the Regulatory Compliance Homepage at dell.com/regulatory_compliance.

Removing the Optical Drive

Prerequisites

- 1 Remove the base cover. See "Removing the Base Cover" on page 15.
- 2 Remove the battery. See "Removing the Battery" on page 17.

Procedure

- 1 Lift the connector latch and use the pull-tab to disconnect the optical-drive cable from the connector on the system board.

- 2 Loosen the four captive screws that secure the optical drive to the computer base.
- 3 Using the pull-tab, lift the optical drive off the computer base.

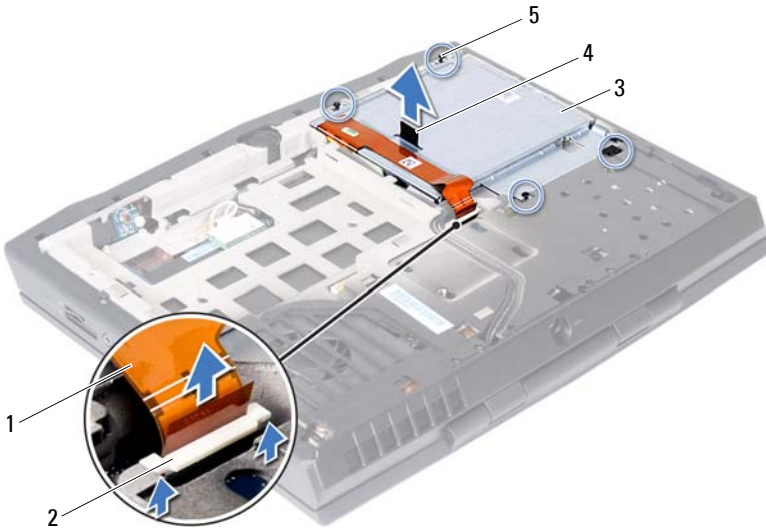

- | | | | |
|---|---------------------|---|-----------------|
| 1 | optical-drive cable | 2 | connector latch |
| 3 | optical drive | 4 | pull tab |
| 5 | captive screws (4) | | |

- 4 Remove the screws that secure the optical-drive cable connector to the optical drive.
- 5 Disconnect the optical-drive cable connector from the connector on the optical drive.

- 6** Gently peel the optical-drive cable from the optical-drive bracket.

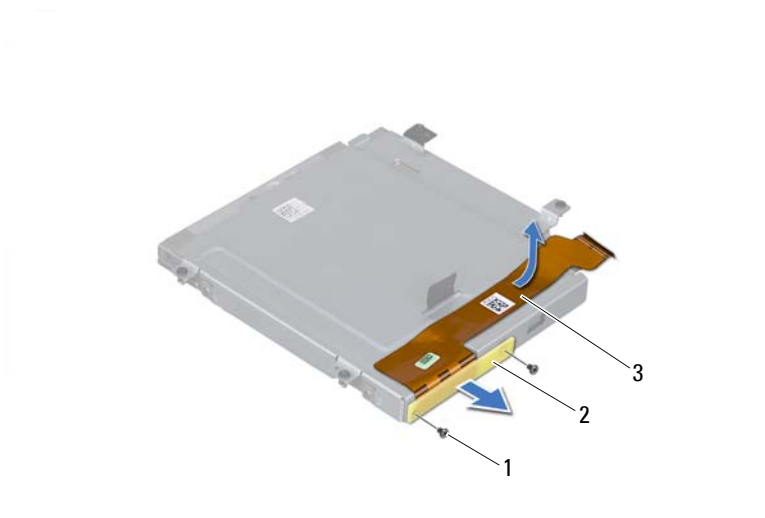

1 screws (2)

2 optical-drive cable connector

3 optical-drive cable

- 7 Remove the screws that secure the optical-drive bracket to the optical drive.
- 8 Using the pull-tab, lift the optical-drive bracket off the optical drive.

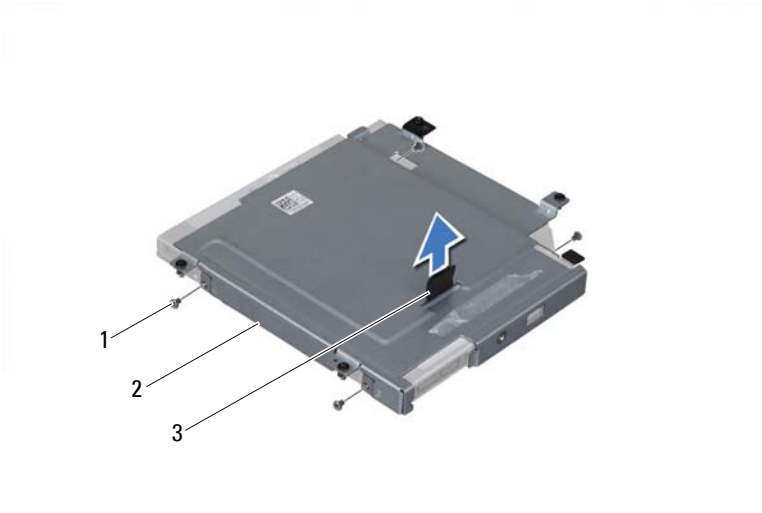

- | | | | |
|---|------------|---|-----------------------|
| 1 | screws (4) | 2 | optical-drive bracket |
| 3 | pull tab | | |

Replacing the Optical Drive

Procedure

- 1 Place the optical-drive bracket on the optical drive and then align the screw holes on the optical-drive bracket with the screw holes on the optical drive.
- 2 Replace the screws that secure the optical-drive bracket to the optical drive.
- 3 Connect the optical-drive cable connector to the connector on the optical drive.

- 4 Replace the screws that secure the optical-drive cable connector to the optical drive.
- 5 Adhere the optical-drive cable to the optical-drive bracket.
- 6 Place the optical drive in the optical-drive bay.
- 7 Tighten the captive screws that secure the optical drive to the computer base.
- 8 Slide the optical-drive cable into the connector on the system board, and press down on the connector latch to secure the cable.

Postrequisites

- 1 Replace the battery. See "Replacing the Battery" on page 18.
- 2 Replace the base cover. See "Removing the Base Cover" on page 15.
- 3 Follow the instructions in "After Working Inside Your Computer" on page 13.

Hard Drive



WARNING: Before working inside your computer, read the safety information that shipped with your computer and follow the steps in "Before You Begin" on page 11. For additional safety best practices information, see the Regulatory Compliance Homepage at dell.com/regulatory_compliance.



CAUTION: To avoid data loss, do not remove the hard drive while the computer is On or in Sleep state.



CAUTION: Hard drives are extremely fragile. Exercise care when handling the hard drive.



NOTE: Dell or Alienware does not guarantee compatibility or provide support for hard drives from sources other than Dell or Alienware.



NOTE: If you are installing a hard drive from a source other than Dell or Alienware, you need to install an operating system, drivers, and utilities on the new hard drive.

Removing the Hard Drive

Procedure

- 1 Remove the base cover. See "Removing the Base Cover" on page 15.
- 2 Remove the battery pack. See "Removing the Battery" on page 17.
- 3 Follow the instructions from step 1 to step 3 in "Removing the Optical Drive" on page 19.

Procedure

- 1 Loosen the three captive screws that secure the hard-drive assembly to the computer base.
- 2 Using the pull-tab, gently lift the hard-drive assembly and then disconnect the hard-drive interposer.

3 Lift the hard-drive assembly off the computer base.

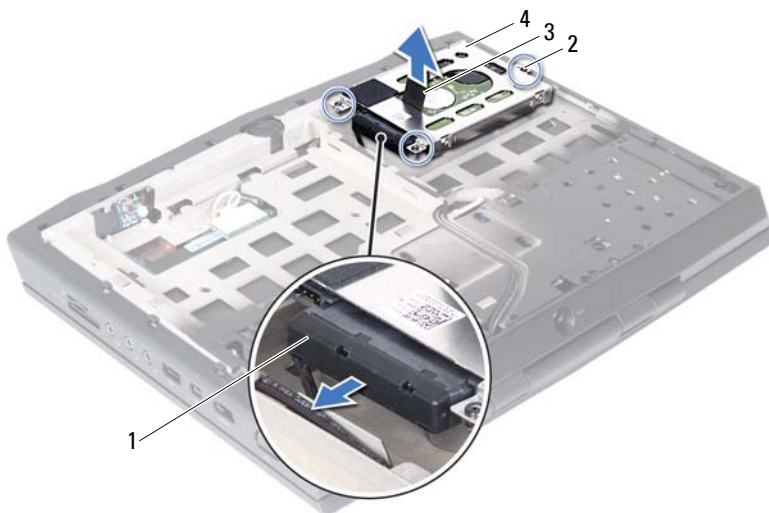

1 hard-drive interposer

2 captive screws (3)

3 pull-tab

4 hard-drive assembly

- 4 Remove the four screws that secure the hard-drive bracket to the hard drive.
- 5 Lift the hard-drive bracket off the hard drive.

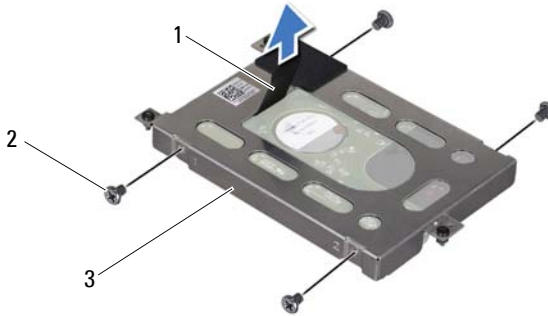

- 1 pull-tab
2 screws (4)
3 hard-drive bracket

CAUTION: When the hard drive is not in the computer, store it in protective antistatic packaging. See "Protecting Against Electrostatic Discharge" in the safety instructions that shipped with your computer.

Replacing the Hard Drive

Procedure

- 1 Place the hard drive in the hard-drive bracket.
- 2 Replace the four screws that secure the hard-drive bracket to the hard drive.
- 3 Connect the interposer to the hard drive.
- 4 Place the hard-drive assembly in the computer base.
- 5 Tighten the three captive screws that secure the hard-drive assembly to the computer base.

Postrequisites

- 1** Follow the instructions from step 6 to step 8 in "Replacing the Optical Drive" on page 22.
- 2** Replace the battery. See "Replacing the Battery" on page 18.
- 3** Replace the base cover. See "Replacing the Base Cover" on page 16.
- 4** Follow the instructions in "After Working Inside Your Computer" on page 13.

Memory Module(s)

 **WARNING:** Before working inside your computer, read the safety information that shipped with your computer and follow the steps in "Before You Begin" on page 11. For additional safety best practices information, see the Regulatory Compliance Homepage at dell.com/regulatory_compliance.

 **NOTE:** Memory modules purchased from Dell or Alienware are covered under your computer warranty.

Your computer has two user-accessible SODIMM connectors.

Removing the Memory Module(s)

Prerequisites

- 1 Remove the base cover. See "Removing the Base Cover" on page 15.
- 2 Remove the battery. See "Removing the Battery" on page 17.

Procedure

- 1 Loosen the captive screws that secure the memory-module cover to the computer base.
- 2 Lift and slide the tabs on the memory-module cover out of the slots on the computer base.



- 1 captive screws (2) 2 memory-module cover

CAUTION: To prevent damage to the memory-module connector, do not use tools to spread the memory module securing clips.

- 3 Use your fingertips to carefully spread apart the securing clips on each end of the memory-module connector until the memory module pops up.

- 4 Slide the memory module out of the memory-module connector.

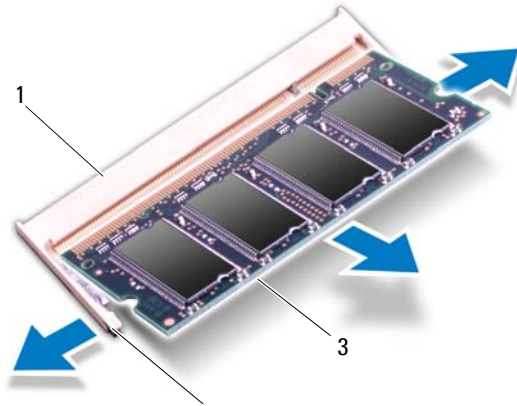

- 1 memory-module connector 2 securing clips (2)
3 memory module

Replacing the Memory Module(s)

Procedure



NOTE: If you need to install memory modules in both memory-module connectors, install a memory module in the lower connector before you install a memory module in the upper connector.

- 1 Align the notch in the memory module with the tab in the memory-module connector.

- 2 Slide the memory module firmly into the connector at a 45-degree angle, and then press the memory module down until it clicks into place. If you do not hear the click, remove the memory module and reinstall it.

 **NOTE:** Your computer may not boot if the memory module is not installed properly.

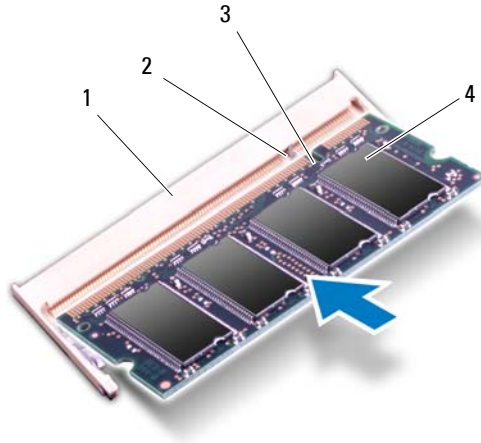

- | | | | |
|---|-------------------------|---|---------------|
| 1 | memory-module connector | 2 | tab |
| 3 | notch | 4 | memory module |

- 3 Slide the tabs on the memory-module cover into the slots on the computer base and lower the memory-module cover into place.
- 4 Tighten the captive screws that secure the memory-module cover to the computer base.

Postrequisites

- 1 Replace the battery. See "Replacing the Battery" on page 18.
- 2 Replace the base cover. See "Replacing the Base Cover" on page 16.
- 3 Follow the instructions in "After Working Inside Your Computer" on page 13.

Center-Control Cover

 **WARNING:** Before working inside your computer, read the safety information that shipped with your computer and follow the steps in "Before You Begin" on page 11. For additional safety best practices information, see the Regulatory Compliance Homepage at dell.com/regulatory_compliance.

Removing the Center-Control Cover

Prerequisites

- 1 Remove the base cover. See "Removing the Base Cover" on page 15.
- 2 Remove the battery. See "Removing the Battery" on page 17.

Procedure

- 1 Remove the screws that secure the center-control cover to the computer base.



- 1 screws (3)
- 2 Turn the computer over and open the display as far as possible.
- 3 Gently pry the center-control cover and then ease the tabs on the center-control cover out of the slots on the palm-rest assembly.

- 4 Lift the center-control cover off the palm-rest assembly.



- 1 center-control cover

Replacing the Center-Control Cover

Procedure

- 1 Align the tabs on the center-control cover with the slots on the palm-rest assembly.
- 2 Gently press around the edges of the center-control cover till it snaps in place.
- 3 Close the display and turn the computer over.
- 4 Replace the screws that secure the center-control cover to the computer base.

Postrequisites

- 1** Replace the battery pack. See "Replacing the Battery" on page 18.
- 2** Replace the base cover. See "Replacing the Base Cover" on page 16.
- 3** Follow the instructions in "After Working Inside Your Computer" on page 13.

Keyboard

 **WARNING:** Before working inside your computer, read the safety information that shipped with your computer and follow the steps in "Before You Begin" on page 11. For additional safety best practices information, see the Regulatory Compliance Homepage at dell.com/regulatory_compliance.

Removing the Keyboard

Prerequisites

- 1 Remove the base cover. See "Removing the Base Cover" on page 15.
- 2 Remove the battery. See "Removing the Battery" on page 17.
- 3 Remove the center-control cover.
See "Removing the Center-Control Cover" on page 33.

Procedure

- 1 Remove the screws that secure the keyboard to the computer base.

 **CAUTION:** The keycaps on the keyboard are fragile, easily dislodged, and time-consuming to replace. Be careful when removing and handling the keyboard.

 **CAUTION:** Be careful when removing and handling the keyboard. Failure to do so could result in scratching the display panel.

- Carefully pry the keyboard up and slide it towards the display till the tabs on the keyboard are released from the palm-rest assembly.
- Turn the keyboard over.



1 screws (3)
3 tabs (4)

2 keyboard
4 palm-rest assembly

- 4 Lift the release latches on the connectors on the system board and disconnect the keyboard cable and keyboard-backlight cable.
- 5 Lift the keyboard off the palm-rest assembly.



1 keyboard cable

2 keyboard backlight cable

Replacing the Keyboard

Procedure

- 1 Slide the keyboard cable and keyboard backlight cable into the connectors on the system board and press down on the connector latches to secure the cables.
- 2 Slide the tabs on the keyboard into the slots on the palm-rest assembly and lower the keyboard into place.
- 3 Gently press around the edges of the keyboard to secure the keyboard under the tab on the palm-rest assembly.
- 4 Replace the screws that secure the keyboard to the computer base.

Postrequisites

- 1** Replace the center-control cover.
See "Replacing the Center-Control Cover" on page 35.
- 2** Replace the battery. See "Replacing the Battery" on page 18.
- 3** Replace the base cover. See "Replacing the Base Cover" on page 16.
- 4** Follow the instructions in "After Working Inside Your Computer" on page 13.

Palm-Rest Assembly

 **WARNING:** Before working inside your computer, read the safety information that shipped with your computer and follow the steps in "Before You Begin" on page 11. For additional safety best practices information, see the Regulatory Compliance Homepage at dell.com/regulatory_compliance.

Removing the Palm-Rest Assembly

Prerequisites

- 1 Remove the base cover. See "Removing the Base Cover" on page 15.
- 2 Remove the battery. See "Removing the Battery" on page 17.

Procedure

- 1 Remove the screws that secure the palm-rest assembly to the computer base.

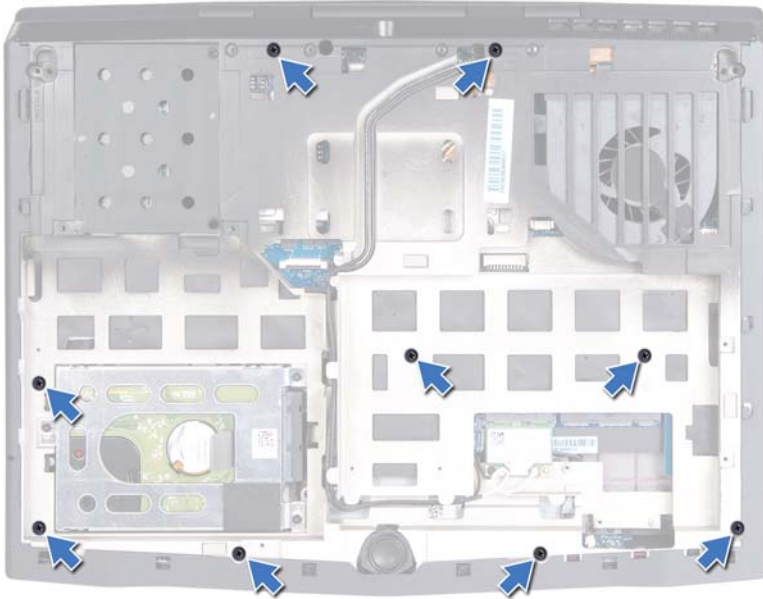

- 2 Turn the computer over and open the display as far as possible.
- 3 Remove the center-control cover (see "Removing the Center-Control Cover" on page 33).
- 4 Remove the keyboard (see "Removing the Keyboard" on page 37).

CAUTION: Use the pull-tabs on top of the connectors to avoid damage to the connectors.

- 5 Lift the connector latches and use the pull-tabs to disconnect the touchpad cable and power-button board cable from the connectors on the system board.
- 6 Disconnect the speakers cable and status-light board cable from the connectors on the system board.

- 7 Remove the two screws that secure the palm-rest assembly to the computer base.

△ CAUTION: Carefully separate the palm-rest assembly from the computer base to avoid damage to the palm-rest assembly.

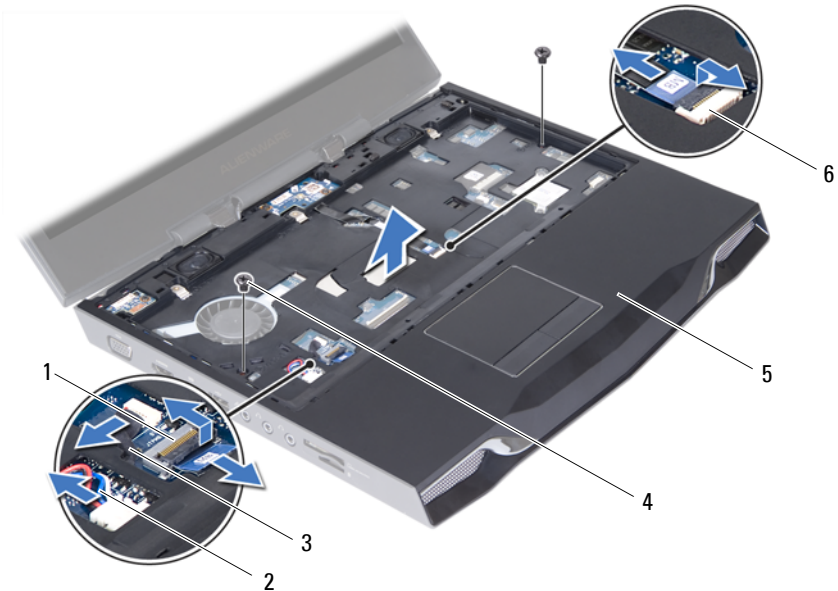

- | | |
|-----------------------------|--------------------------------------|
| 1 touch-pad cable connector | 2 speakers cable |
| 3 status-light board cable | 4 screws (2) |
| 5 palm-rest assembly | 6 power-button board cable connector |

- 8 Pry out the palm-rest assembly along the rear edge and then ease the palm-rest assembly from the computer base.
- 9 Lift the palm-rest assembly off the computer base.

Replacing the Palm-Rest Assembly

Procedure

- 1 Align the palm-rest assembly on the computer base and gently snap the palm-rest assembly into place.
- 2 Replace the two screws that secure the palm-rest assembly to the computer base.
- 3 Connect the speakers cable and status-light board cable to the connectors on the system board.
- 4 Slide the touch-pad cable and power-button board cable into their connectors on the system board, and press down on their connector latches to secure the cables.

Postrequisites

- 1 Replace the keyboard. See "Replacing the Keyboard" on page 39.
- 2 Replace the center-control cover.
See "Replacing the Center-Control Cover" on page 35.
- 3 Close the display and turn the computer over.
- 4 Replace the screws that secure the palm-rest assembly to the computer base.
- 5 Replace the battery. See "Replacing the Battery" on page 18.
- 6 Replace the base cover. See "Replacing the Base Cover" on page 16.
- 7 Follow the instructions in "After Working Inside Your Computer" on page 13.

Wireless Mini-Card(s)/WirelessHD Card (Optional)



WARNING: Before working inside your computer, read the safety information that shipped with your computer and follow the steps in "Before You Begin" on page 11. For additional safety best practices information, see the Regulatory Compliance Homepage at dell.com/regulatory_compliance.



NOTE: Dell or Alienware does not guarantee compatibility or provide support for Mini-Cards from sources other than Dell or Alienware.

If you ordered a wireless mini-card with your computer, the card is already installed.



NOTE: The procedure for removing and replacing the WirelessHD card (optional) is the same as Mini-Card(s).

Removing the Mini-Card(s)

Prerequisites

- 1 Remove the base cover. See "Removing the Base Cover" on page 15.
- 2 Remove the battery. See "Removing the Battery" on page 17.

Procedure

- 1 Disconnect the antenna cables from the connectors on the mini-card.
- 2 Remove the screw that secures the mini-card to the system board.

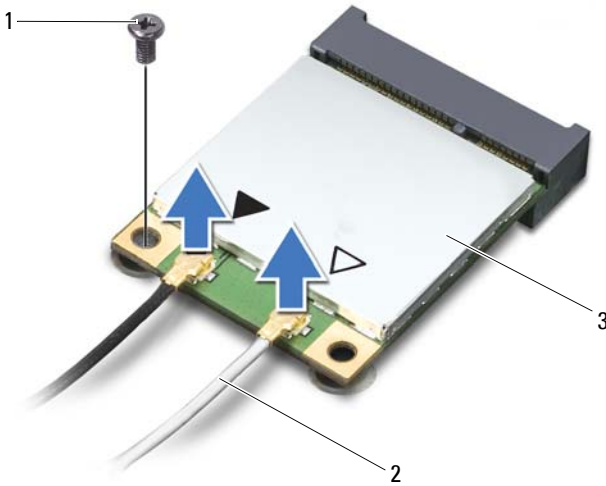

1 screw
3 Mini-Card

2 antenna cables (2)

- 3 Slide and remove the mini-card out of the connector on the system board.

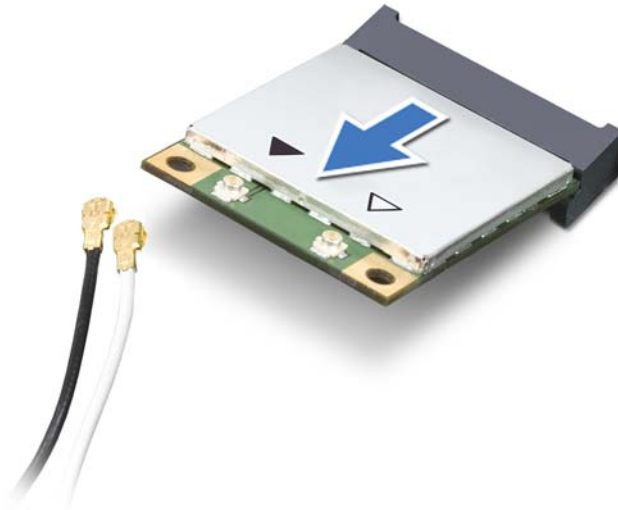

Replacing the Mini-Card(s)

Procedure

- 1 Remove the new Mini-Card from its packaging.

△ **CAUTION:** Use firm and even pressure to slide the mini-card into place. If you use excessive force, you may damage the connector.

△ **CAUTION:** The connectors are keyed to ensure correct insertion. If you feel resistance, check the connectors on the mini-card and on the system board, and realign the mini-card.

- 2 Insert the mini-card connector at a 45-degree angle into the connector on the system board.
- 3 Press the other end of the mini-card down into the slot on the system board and replace the screw that secures the mini-card to the system board.

- 4 Connect the mini-card cables to the connectors on the mini-card. The following table provides the antenna cable color scheme for each mini-card supported by your computer:

Connectors on the Mini-Card	Antenna Cable Color Scheme
WLAN (2 antenna cables)	
Main WLAN (white triangle)	white
Auxiliary WLAN (black triangle)	black

Postrequisites

- 1 Replace the battery. See "Replacing the Battery" on page 18.
- 2 Replace the base cover. See "Replacing the Base Cover" on page 16.
- 3 Follow the instructions in "After Working Inside Your Computer" on page 13.

Power-Button Board

 **WARNING:** Before working inside your computer, read the safety information that shipped with your computer and follow the steps in "Before You Begin" on page 11. For additional safety best practices information, see the Regulatory Compliance Homepage at dell.com/regulatory_compliance.

Removing the Power-Button Board

Prerequisites

- 1 Remove the base cover. See "Removing the Base Cover" on page 15.
- 2 Remove the battery. See "Removing the Battery" on page 17.
- 3 Remove the center-control cover.
See "Removing the Center-Control Cover" on page 33.
- 4 Remove the keyboard. See "Removing the Keyboard" on page 37.
- 5 Remove the palm-rest assembly.
See "Removing the Palm-Rest Assembly" on page 41.

Procedure

- 1 Gently peel the power-button board cable from the palm-rest assembly.
- 2 Remove the screws that secure the power-button board to the palm-rest assembly.

- Carefully lift the power-button board and release its cable from the slot on the palm-rest assembly.

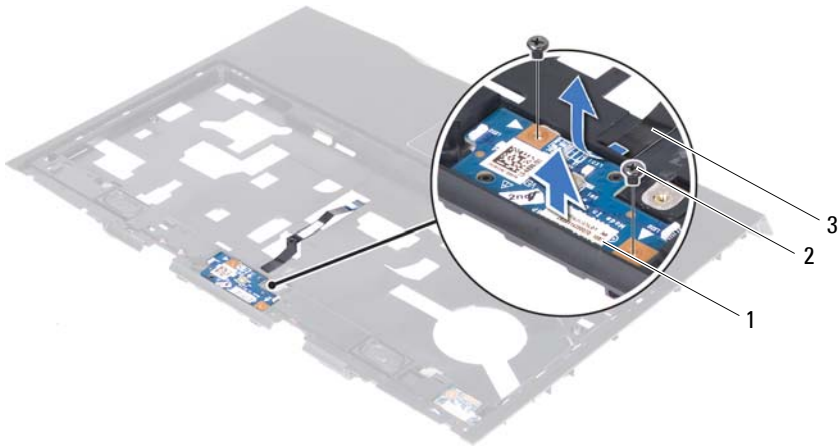

- | | | | |
|---|--------------------------|---|------------|
| 1 | power-button board | 2 | screws (2) |
| 3 | power-button board cable | | |

Replacing the Power-Button Board

Procedure

- Slide the power-button board cable through the slot on the palm-rest assembly.
- Use the alignment posts on the palm-rest assembly to place the power-button board in place.
- Replace the screws that secure the power-button board to the palm-rest assembly.
- Adhere the power-button board cable to the palm-rest assembly.

Postrequisites

- 1** Replace the palm-rest assembly.
See "Replacing the Palm-Rest Assembly" on page 44.
- 2** Replace the keyboard. See "Replacing the Keyboard" on page 39.
- 3** Replace the center-control cover.
See "Replacing the Center-Control Cover" on page 35.
- 4** Replace the battery pack. See "Replacing the Battery" on page 18.
- 5** Replace the base cover. See "Replacing the Base Cover" on page 16.
- 6** Follow the instructions in "After Working Inside Your Computer" on page 13.

Status-Lights Board



WARNING: Before working inside your computer, read the safety information that shipped with your computer and follow the steps in "Before You Begin" on page 11. For additional safety best practices information, see the Regulatory Compliance Homepage at dell.com/regulatory_compliance.

Removing the Status-Lights Board

Prerequisites

- 1 Remove the base cover. See "Removing the Base Cover" on page 15.
- 2 Remove the battery. See "Removing the Battery" on page 17.
- 3 Remove the center-control cover.
See "Removing the Center-Control Cover" on page 33.
- 4 Remove the keyboard. See "Removing the Keyboard" on page 37.
- 5 Remove the palm-rest assembly.
See "Removing the Palm-Rest Assembly" on page 41.

Procedure

- 1 Turn the palm-rest assembly over.
- 2 Note the routing of status-light board cable and remove the cable from the routing guides.



NOTE: If the status-light board cable is under the speakers cable, remove the speakers cable first and then remove the status-light board cable.

3 Turn the palm-rest assembly over.

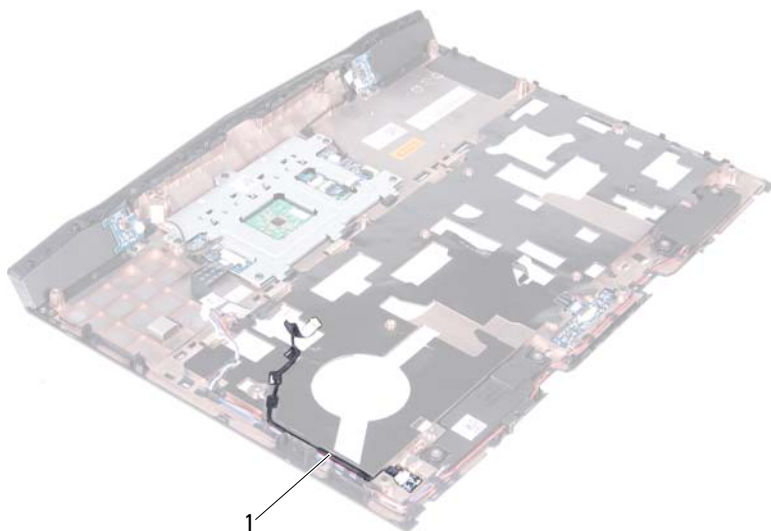

1 status-light board cable

- 4 Remove the screw that secures the status-light board to the palm-rest assembly.
- 5 Carefully lift the status-light board and release its cable from the slot on the palm-rest assembly.



1 status-light board

2 screw

Replacing the Status-Lights Board

Procedure.

- 1 Slide the status-light board cable through the slot in the palm-rest assembly.
- 2 Align the slot on the status-light board with the alignment post on the palm-rest assembly.
- 3 Replace the screw that secures the status-light board to the palm-rest assembly.
- 4 Turn the palm-rest assembly over.
- 5 Route the status-light board cable through the routing guides on the palm-rest assembly.

Postrequisites

- 6** Replace the palm-rest assembly.
See "Replacing the Palm-Rest Assembly" on page 44.
- 7** Replace the keyboard. See "Replacing the Keyboard" on page 39.
- 8** Replace the center-control cover.
See "Replacing the Center-Control Cover" on page 35.
- 9** Replace the battery. See "Replacing the Battery" on page 18.
- 10** Replace the base cover. See "Replacing the Base Cover" on page 16.
- 11** Follow the instructions in "After Working Inside Your Computer" on page 13.

Speakers

 **WARNING:** Before working inside your computer, read the safety information that shipped with your computer and follow the steps in "Before You Begin" on page 11. For additional safety best practices information, see the Regulatory Compliance Homepage at dell.com/regulatory_compliance.

Removing the Speakers

Prerequisites

- 1 Remove the base cover. See "Removing the Base Cover" on page 15.
- 2 Remove the battery. See "Removing the Battery" on page 17.
- 3 Remove the center-control cover.
See "Removing the Center-Control Cover" on page 33.
- 4 Remove the keyboard. See "Removing the Keyboard" on page 37.
- 5 Remove the palm-rest assembly.
See "Removing the Palm-Rest Assembly" on page 41.

Procedure

- 1 Turn the palm-rest assembly over.
- 2 Note the routing of speakers cable and remove the cable from the routing guides.

 **NOTE:** If the speakers cable is under the status-light board cable, remove the status-light board cable first and then remove the speakers cable.

- 3 Remove the four screws that secure the speakers to the palm-rest assembly.
- 4 Lift the speakers along with the cable away from the palm-rest assembly.

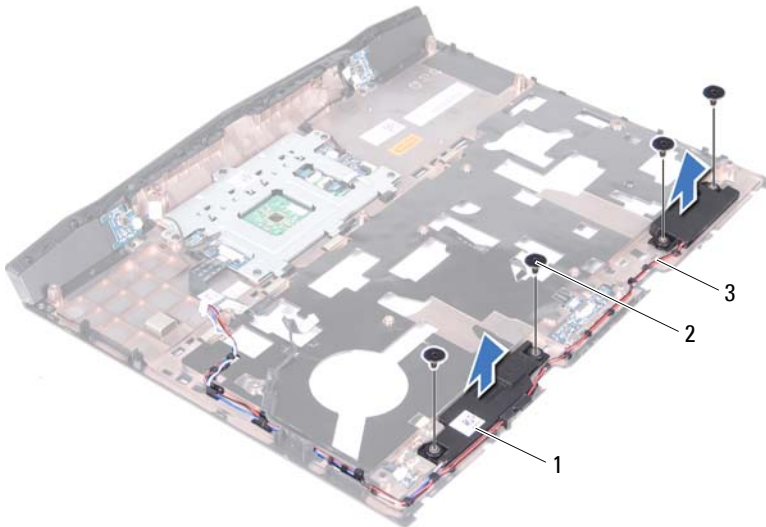

- 1 speakers (2)
- 3 speakers cable

- 2 screws (4)

Replacing the Speakers

Procedure

- 1 Align the screw holes on the speakers with the screw holes on the palm-rest assembly and route the speakers cable through the routing guides.
- 2 Replace the screws that secure the speakers to the palm-rest assembly.
- 3 Turn the palm-rest assembly over.

Postrequisites

- 1** Replace the palm-rest assembly.
See "Replacing the Palm-Rest Assembly" on page 44.
- 2** Replace the keyboard. See "Replacing the Keyboard" on page 39.
- 3** Replace the center-control cover.
See "Replacing the Center-Control Cover" on page 35.
- 4** Replace the battery. See "Replacing the Battery" on page 18.
- 5** Replace the base cover. See "Replacing the Base Cover" on page 16.
- 6** Follow the instructions in "After Working Inside Your Computer" on page 13.

Subwoofer

 **WARNING:** Before working inside your computer, read the safety information that shipped with your computer and follow the steps in "Before You Begin" on page 11. For additional safety best practices information, see the Regulatory Compliance Homepage at dell.com/regulatory_compliance.

Removing the Subwoofer

Prerequisites

- 1 Remove the base cover. See "Removing the Base Cover" on page 15.
- 2 Remove the battery. See "Removing the Battery" on page 17.
- 3 Remove the center-control cover.
See "Removing the Center-Control Cover" on page 33.
- 4 Remove the keyboard. See "Removing the Keyboard" on page 37.
- 5 Remove the palm-rest assembly.
See "Removing the Palm-Rest Assembly" on page 41.

Procedure

- 1 Disconnect the subwoofer cable from the connector on the system board.
- 2 Note the routing of subwoofer cable and remove the cable from the routing guides.

- 3 Lift the subwoofer along with the cable off the computer base.

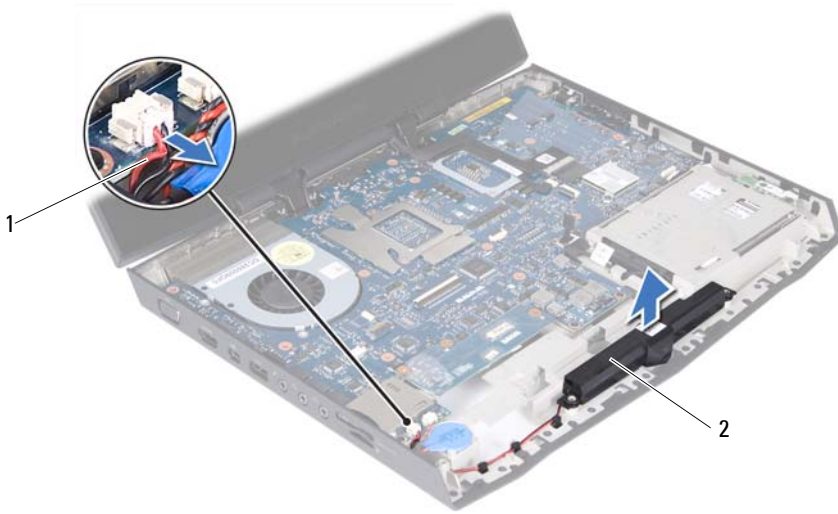

1 subwoofer cable

2 subwoofer

Replacing the Subwoofer

Procedure

- 1 Align the slots on the subwoofer with the alignment posts on the computer base.
- 2 Route the subwoofer cable through the routing guides.
- 3 Connect the subwoofer cable to the connector on the system board.

Postrequisites

- 1 Replace the palm-rest assembly.
See "Replacing the Palm-Rest Assembly" on page 44.
- 2 Replace the keyboard. See "Replacing the Keyboard" on page 39.
- 3 Replace the center-control cover.
See "Replacing the Center-Control Cover" on page 35.

- 4** Replace the battery. See "Replacing the Battery" on page 18.
- 5** Replace the base cover. See "Replacing the Base Cover" on page 16.
- 6** Follow the instructions in "After Working Inside Your Computer" on page 13.

Internal Card with Bluetooth Wireless Technology



WARNING: Before working inside your computer, read the safety information that shipped with your computer and follow the steps in "Before You Begin" on page 11. For additional safety best practices information, see the Regulatory Compliance Homepage at dell.com/regulatory_compliance.

If you ordered a card with Bluetooth wireless technology with your computer, it is already installed.

Removing the Bluetooth Card

Prerequisites

- 1 Remove the base cover. See "Removing the Base Cover" on page 15.
- 2 Remove the battery. See "Removing the Battery" on page 17.
- 3 Remove the center-control cover.
See "Removing the Center-Control Cover" on page 33.
- 4 Remove the keyboard. See "Removing the Keyboard" on page 37.
- 5 Remove the palm-rest assembly.
See "Removing the Palm-Rest Assembly" on page 41.

Procedure

- 1 Disconnect the Bluetooth-card cable from the connector on the system board.
- 2 Remove the screw that secures the Bluetooth card to the computer base.
- 3 Note the routing of Bluetooth-card cable and remove the cable from the routing guides.
- 4 Lift the Bluetooth card along with the cable off the computer base.

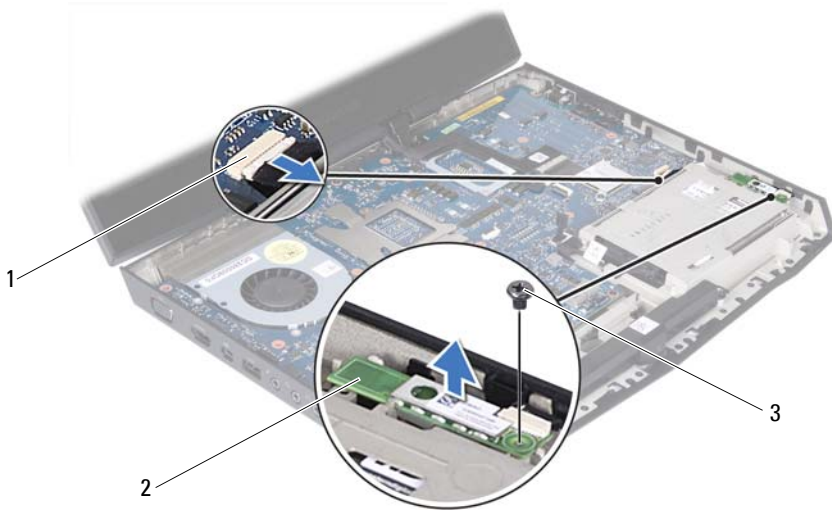

- 1 Bluetooth-card cable connector 2 Bluetooth card
3 screw

Replacing the Bluetooth Card

Procedure

- 1 Align the screw hole on the Bluetooth card with the screw hole on the system board.
- 2 Replace the screw that secures the Bluetooth card to the computer base.
- 3 Connect the Bluetooth-card cable to the connector on the system board.

Postrequisites

- 1 Replace the palm-rest assembly.
See "Replacing the Palm-Rest Assembly" on page 44.
- 2 Replace the keyboard. See "Replacing the Keyboard" on page 39.
- 3 Replace the center-control cover.
See "Replacing the Center-Control Cover" on page 35.

- 4** Replace the battery. See "Replacing the Battery" on page 18.
- 5** Replace the base cover. See "Replacing the Base Cover" on page 16.
- 6** Follow the instructions in "After Working Inside Your Computer" on page 13.

Coin-Cell Battery

 **WARNING:** Before working inside your computer, read the safety information that shipped with your computer and follow the steps in "Before You Begin" on page 11. For additional safety best practices information, see the Regulatory Compliance Homepage at dell.com/regulatory_compliance.

 **WARNING:** The battery may explode if installed incorrectly. Replace the battery only with the same or equivalent type. Discard used batteries according to the manufacturer's instructions.

Removing the Coin-Cell Battery

 **CAUTION:** Removing the coin-cell battery resets the BIOS settings to default. It is recommended that you note the BIOS settings before removing the coin-cell battery.

Prerequisites

- 1 Remove the base cover. See "Removing the Base Cover" on page 15.
- 2 Remove the battery pack. See "Removing the Battery" on page 17.
- 3 Remove the center-control cover.
See "Removing the Center-Control Cover" on page 33.
- 4 Remove the keyboard. See "Removing the Keyboard" on page 37.
- 5 Remove the palm-rest assembly.
See "Removing the Palm-Rest Assembly" on page 41.

Procedure

- 1 Disconnect the coin-cell battery cable from the connector on the system board.
- 2 Gently pry out the coin-cell battery from the slot on the computer base.

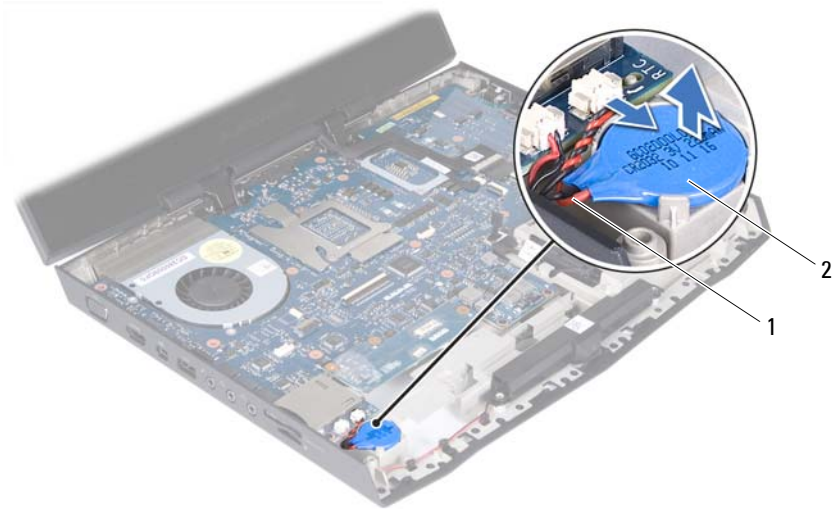

1 coin-cell battery cable

2 coin-cell battery

Replacing the Coin-Cell Battery

Procedure

- 1 Use the adhesive on the coin-cell battery and adhere it to slot on the computer base.
- 2 Connect the coin-cell battery cable to the connector on the system board.

Postrequisites

- 1** Replace the palm-rest assembly.
See "Replacing the Palm-Rest Assembly" on page 44).
- 2** Replace the keyboard. See "Replacing the Keyboard" on page 39).
- 3** Replace the center-control cover.
See "Replacing the Center-Control Cover" on page 35.
- 4** Replace the battery. See "Replacing the Battery" on page 18.
- 5** Replace the base cover. See "Replacing the Base Cover" on page 16.
- 6** Follow the instructions in "After Working Inside Your Computer" on page 13.

Display Assembly



WARNING: Before working inside your computer, read the safety information that shipped with your computer and follow the steps in "Before You Begin" on page 11. For additional safety best practices information, see the Regulatory Compliance Homepage at dell.com/regulatory_compliance.

Removing the Display Assembly

Prerequisites

- 1 Remove the base cover. See "Removing the Base Cover" on page 15.
- 2 Remove the battery pack. See "Removing the Battery" on page 17.
- 3 Disconnect the antenna cables from the mini-card(s). See "Removing the Mini-Card(s)" on page 45.

- 4 Note the routing of the WirelessHD card (optional) and mini-card antenna cables and remove them from the routing guides on the computer base.

 **NOTE:** The WirelessHD card is optional and may not be present in your computer.

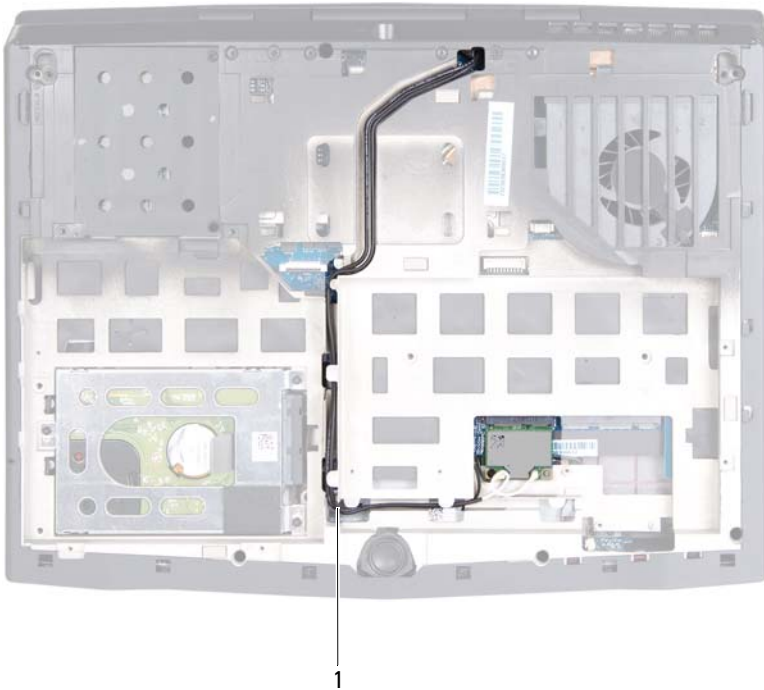

- 1 Mini-Card antenna cables
- 5 Turn the computer over and open the display as far as possible.
- 6 Remove the center-control cover.
See "Removing the Center-Control Cover" on page 33.
- 7 Remove the keyboard. See "Removing the Keyboard" on page 37.
- 8 Remove the palm-rest assembly.
See "Removing the Palm-Rest Assembly" on page 41.

Procedure

- 1 Using the pull-tab, disconnect the display cable from the connector on the system board.
- 2 Disconnect the logo-board cable from the connector on the system board.
- 3 Gently peel the display cable and the logo-board cable from the system board.
- 4 Remove the screws that secure the display assembly to the computer base.
- 5 Gently slide the WirelessHD (optional) and mini-card antenna cables out through the slot on the computer base.
- 6 Lift the display assembly off the computer.

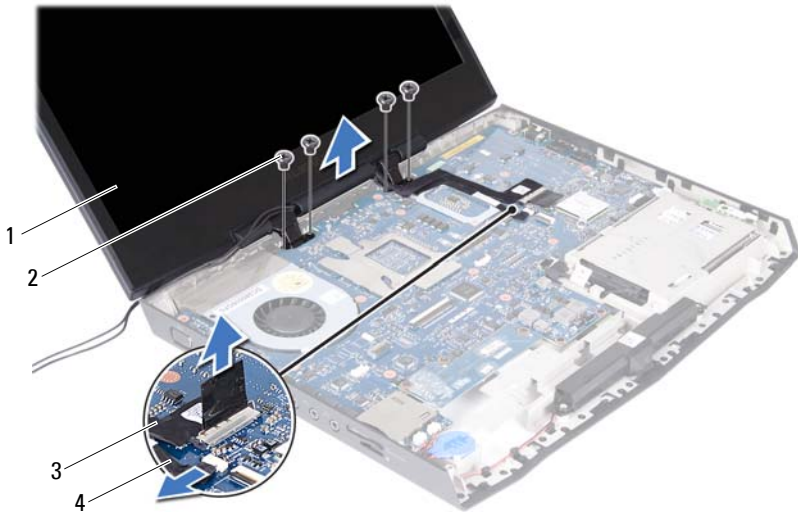

- 1 display assembly
- 3 display cable

- 2 screws (4)
- 4 logo-board cable

Replacing the Display Assembly

Procedure

- 1 Slide the WirelessHD (optional) and mini-card antenna cables through the slot on the computer base.
- 2 Place the display assembly in position and replace the screws that secure the display assembly to the computer base.



NOTE: Ensure that no cables lie between the display assembly and the computer base.

- 3 Connect the display cable and the logo-board cable to the connectors on the system board.

Postrequisites

- 1 Replace the palm-rest assembly.
See "Replacing the Palm-Rest Assembly" on page 44.
- 2 Replace the keyboard. See "Replacing the Keyboard" on page 39.
- 3 Replace the center-control cover.
See "Replacing the Center-Control Cover" on page 35.
- 4 Turn the computer over and route the WirelessHD card and mini-card antenna cables through the routing guides on the computer base.
- 5 Connect the Mini-Card antenna cables to the mini-card(s).
See "Replacing the Mini-Card(s)" on page 47.
- 6 Replace the battery. See "Replacing the Battery" on page 18.
- 7 Replace the base cover. See "Replacing the Base Cover" on page 16.
- 8 Follow the instructions in "After Working Inside Your Computer" on page 13.

Mini-Card Board

 **WARNING:** Before working inside your computer, read the safety information that shipped with your computer and follow the steps in "Before You Begin" on page 11. For additional safety best practices information, see the Regulatory Compliance Homepage at dell.com/regulatory_compliance.

Removing the Mini-Card Board

Prerequisites

- 1 Remove the base cover. See "Removing the Base Cover" on page 15.
- 2 Remove the battery. See "Removing the Battery" on page 17.
- 3 Remove the mini-card(s). See "Removing the Mini-Card(s)" on page 45.
- 4 Remove the center-control cover.
See "Removing the Center-Control Cover" on page 33.
- 5 Remove the keyboard. See "Removing the Keyboard" on page 37.
- 6 Remove the palm-rest assembly.
See "Removing the Palm-Rest Assembly" on page 41.

Procedure

- 1 Remove the screws that secure the mini-card board to the computer base.
- 2 Lift the mini-card board to disconnect the connector on the mini-card board from the connector on the system board.

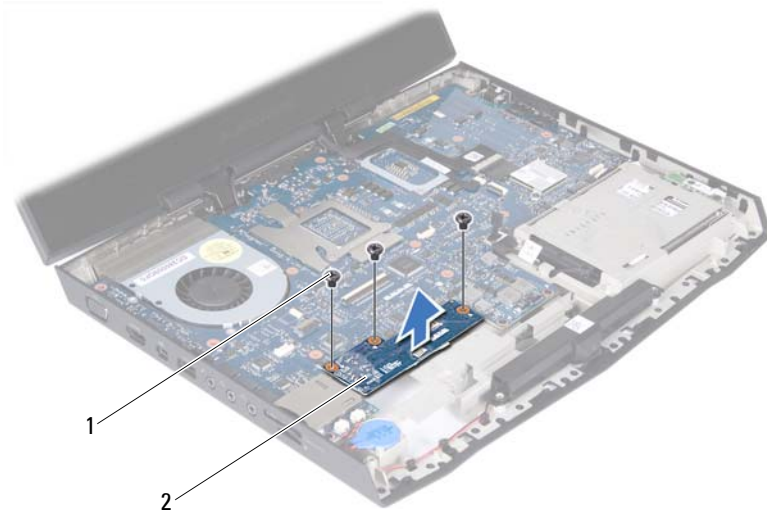

1 screws (3)

2 Mini-Card board

Replacing the Mini-Card Board

Procedure

- 1 Align the connector on the mini-card board with the connector on the system board and press gently.
- 2 Replace the three screws that secure the mini-card board to the computer base.

Postrequisites

- 3** Replace the palm-rest assembly.
See "Lift the palm-rest assembly off the computer base." on page 43.
- 4** Replace the keyboard. See "Replacing the Keyboard" on page 39.
- 5** Replace the center-control cover.
See "Replacing the Center-Control Cover" on page 35.
- 6** Replace the mini-card(s). See "Replacing the Mini-Card(s)" on page 47.
- 7** Replace the battery. See "Replacing the Battery" on page 18.
- 8** Replace the base cover. See "Replacing the Base Cover" on page 16.
- 9** Follow the instructions in "After Working Inside Your Computer" on page 13.

System Board



WARNING: Before working inside your computer, read the safety information that shipped with your computer and follow the steps in "Before You Begin" on page 11. For additional safety best practices information, see the Regulatory Compliance Homepage at dell.com/regulatory_compliance.

The system board's BIOS chip contains the Service Tag, which is also visible on a barcode label at the bottom of the computer.

Removing the System Board

Prerequisites

- 1 Remove any installed card or blank from the 9-in-1 Media Card reader.
- 2 Remove the base cover. See "Removing the Base Cover" on page 15.
- 3 Remove the battery pack. See "Removing the Battery" on page 17.
- 4 Remove the mini-card(s). See "Removing the Mini-Card(s)" on page 45.
- 5 Follow the instructions from step 1 to step 3 in "Removing the Optical Drive" on page 19.
- 6 Follow the instructions from step 1 to step 3 in Removing the Hard Drive.
- 7 Remove the memory module(s).
See "Removing the Memory Module(s)" on page 29.
- 8 Remove the center-control cover.
See "Removing the Center-Control Cover" on page 33.
- 9 Remove the keyboard. See "Removing the Keyboard" on page 37.
- 10 Remove the palm-rest assembly.
See "Removing the Palm-Rest Assembly" on page 41.
- 11 Remove the Mini-Card board.
See "Removing the Mini-Card Board" on page 77.

Procedure

- 1 Using the pull-tab, disconnect the display cable and the hard-drive cable from the connectors on the system board.
- 2 Disconnect the logo-board cable, Bluetooth-card cable, coin-cell battery cable, and subwoofer cable from the connectors on the system board.
- 3 Remove the screws that secure the system board to the computer base.

- 4** Lift and ease the connectors on the system board out of the slots on the computer base.

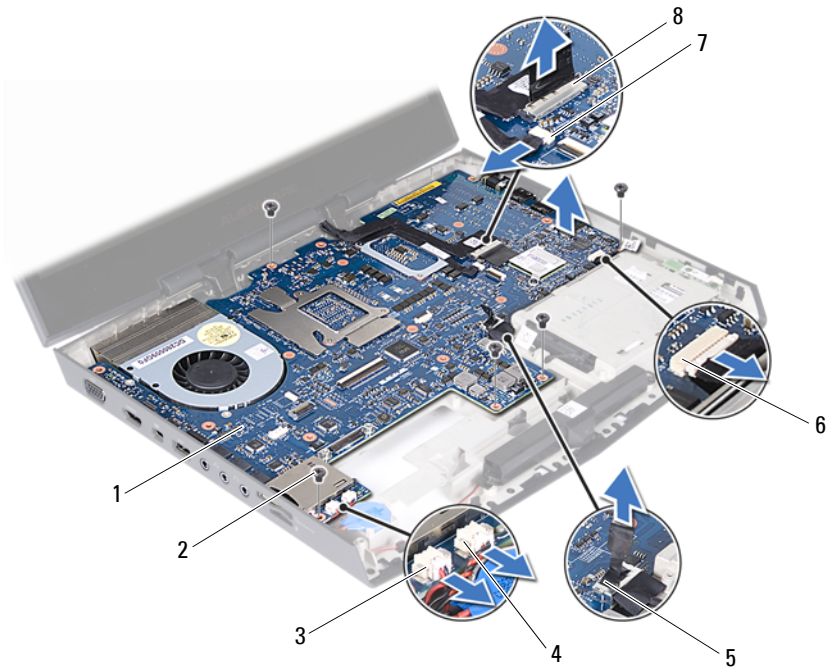

- | | | | |
|---|----------------------------|---|-----------------------------------|
| 1 | system board | 2 | screws (5) |
| 3 | subwoofer cable connector | 4 | coin-cell battery cable connector |
| 5 | hard-drive cable connector | 6 | Bluetooth card cable connector |
| 7 | logo-board cable connector | 8 | display-cable connector |

- 5** Turn the system board over.
- 6** Remove the thermal fan. See "Removing the Thermal Fan" on page 87.
- 7** Remove the thermal cooling assembly.
See "Removing the Thermal Cooling Assembly" on page 89.
- 8** Remove the processor module.
See "Removing the Processor Module" on page 93.

Replacing the System Board

Procedure

- 1 Replace the processor module.
See "Replacing the Processor Module" on page 95.
- 2 Replace the thermal cooling assembly.
See "Replacing the Thermal Cooling Assembly" on page 90.
- 3 Replace the thermal fan. See "Replacing the Thermal Fan" on page 88.
- 4 Turn the system board over.
- 5 Align the connectors on the system board with the slots on the computer base and place it on the computer base.



NOTE: Ensure that no cables lie between the system board and the computer base.

- 6 Replace the screws that secure the system board to the computer base.
- 7 Connect the display cable, logo-board cable, Bluetooth-card cable, hard-drive cable, coin-cell battery cable, and subwoofer cable to the connectors on the system-board.

Postrequisites

- 8 Replace the mini-card board.
See "Replacing the Mini-Card Board" on page 78.
- 9 Replace the palm-rest assembly.
See "Replacing the Palm-Rest Assembly" on page 44.
- 10 Replace the keyboard. See "Replacing the Keyboard" on page 39.
- 11 Replace the center-control cover.
See "Replacing the Center-Control Cover" on page 35.
- 12 Replace the memory module(s).
See "Replacing the Memory Module(s)" on page 31.
- 13 Follow the instructions from step 3 to step 5 in Replacing the Hard Drive.
- 14 Follow the instructions from step 6 to step 8 in "Replacing the Optical Drive" on page 22.
- 15 Replace the mini-card(s). See "Replacing the Mini-Card(s)" on page 47.
- 16 Replace the battery. See "Replacing the Battery" on page 18.

- 17 Replace the base cover. See "Replacing the Base Cover" on page 16)
- 18 Replace any cards or blank that you removed from the 9-in-1 Media Card reader.
- 19 Follow the instructions in "After Working Inside Your Computer" on page 13.

Entering the Service Tag in the BIOS

- 1 Ensure that the AC adapter is plugged in and that the main battery is installed properly.
- 2 Turn on the computer.
- 3 Press <F2> during POST to enter the system setup program.
- 4 Navigate to the **Security** tab and enter the service tag in the **Set Service Tag** field.

Thermal Fan



WARNING: Before working inside your computer, read the safety information that shipped with your computer and follow the steps in "Before You Begin" on page 11. For additional safety best practices information, see the Regulatory Compliance Homepage at dell.com/regulatory_compliance.

Removing the Thermal Fan

Prerequisites

- 1 Follow the instructions from step 1 to step 4 in "Removing the System Board" on page 81.

Procedure

- 1 Disconnect the thermal-fan cable from the connector on the system board.
- 2 Remove the screws that secure the thermal fan to the system board.

- 3 Lift the thermal fan and gently peel the tape that secures the thermal fan to the thermal cooling assembly.

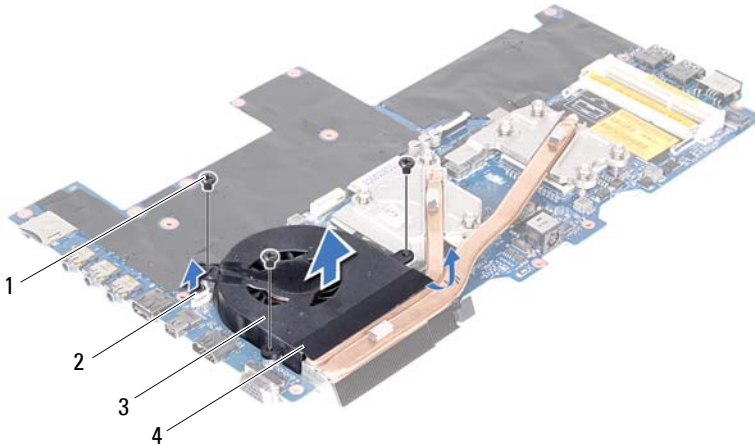

- | | | | |
|---|-------------|---|-----------------------------|
| 1 | screws (3) | 2 | thermal fan cable connector |
| 3 | thermal fan | 4 | tape |

Replacing the Thermal Fan

Procedure

- 1 Align the screw holes on the thermal fan with the screw holes on the system board.
- 2 Adhere the tape to secure the thermal fan to the thermal cooling assembly.
- 3 Replace the screws that secure the thermal fan to the system board.
- 4 Connect the thermal-fan cable to the connector on the system board.

Postrequisites

- 1 Follow the instructions from step 2 to step 18 in "Replacing the System Board" on page 84.
- 2 Follow the instructions in "After Working Inside Your Computer" on page 13.

Thermal Cooling Assembly



WARNING: Before working inside your computer, read the safety information that shipped with your computer and follow the steps in "Before You Begin" on page 11. For additional safety best practices information, see the Regulatory Compliance Homepage at dell.com/regulatory_compliance.



WARNING: If you remove the thermal cooling assembly from the computer when the thermal cooling assembly is hot, *do not touch* the metal housing of the thermal cooling assembly.

Removing the Thermal Cooling Assembly

Prerequisites

- 1 Follow the instructions from step 1 to step 6 in "Removing the System Board" on page 81.

Procedure

- 1 In sequential order (indicated on the thermal cooling assembly), loosen the captive screws that secure the thermal cooling assembly to the system board.

- Carefully lift thermal cooling assembly away from the system board.

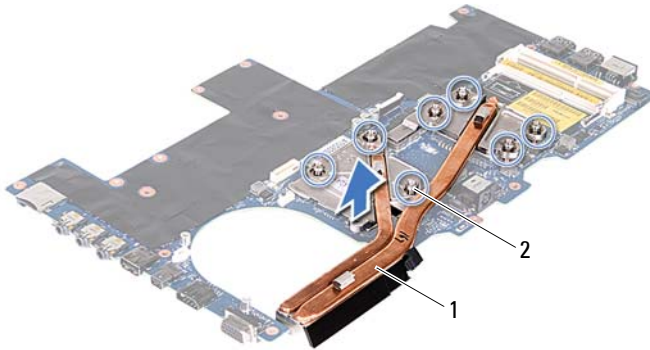

1 thermal cooling assembly

2 captive screws (7)

NOTE: The appearance of the thermal cooling assembly may differ based on your computer model.

Replacing the Thermal Cooling Assembly

NOTE: The original thermal grease can be reused if the original processor and thermal cooling assembly are reinstalled together. If either the processor or the thermal cooling assembly is replaced, use the thermal pad provided in the kit to ensure that thermal conductivity is achieved.

Procedure

- Clean the thermal grease from the bottom of the thermal cooling assembly and reapply it.
- Align the captive screws on the thermal cooling assembly with the screw holes on the system board and tighten the screws in sequential order (indicated on the thermal cooling assembly).

Postrequisites

- 1** Follow the instructions from step 3 to step 18 in "Replacing the System Board" on page 84.
- 2** Follow the instructions in "After Working Inside Your Computer" on page 13.

Processor Module

 **WARNING:** Before working inside your computer, read the safety information that shipped with your computer and follow the steps in "Before You Begin" on page 11. For additional safety best practices information, see the Regulatory Compliance Homepage at dell.com/regulatory_compliance.

Removing the Processor Module

Prerequisites

- 1 Follow the instructions from step 1 to step 7 in "Removing the System Board" on page 81.

Procedure

 **CAUTION:** To prevent intermittent contact between the ZIF-socket and the processor when removing or replacing the processor, press to apply slight pressure to the centre of the processor while turning the cam screw.

 **CAUTION:** To avoid damage to the processor, hold the screwdriver so that it is perpendicular to the processor when turning the cam screw.

- 1 To loosen the ZIF socket, use a small, flat-blade screwdriver and rotate the ZIF-socket cam screw counterclockwise until it comes to the cam stop.

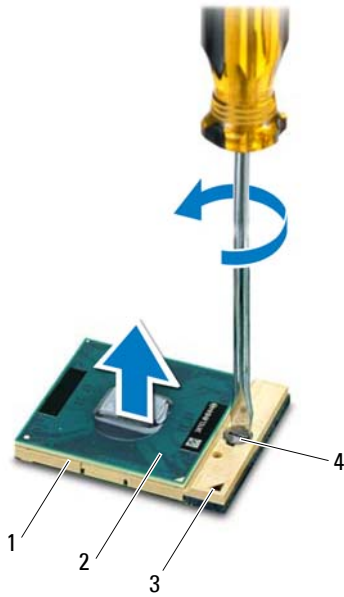

- | | | | |
|---|--------------|---|----------------------|
| 1 | ZIF socket | 2 | processor module |
| 3 | pin-1 corner | 4 | ZIF-socket cam screw |

CAUTION: To ensure maximum cooling for the processor module, do not touch the heat transfer areas on the processor thermal-cooling assembly. The oils in your skin can reduce the heat transfer capability of the thermal pads.

CAUTION: When removing the processor module, pull the module straight up. Be careful not to bend the pins on the processor module.

- 2 Lift the processor module off the ZIF socket.

Replacing the Processor Module

 **NOTE:** If a new processor module is installed, you will receive a new thermal cooling assembly, which will include an affixed thermal pad, or you will receive a new thermal pad along with documentation to illustrate proper installation.

Procedure

- 1 Align the pin-1 corner of the processor module with the pin-1 corner of the ZIF socket.

 **NOTE:** The pin-1 corner of the processor module has a triangle that aligns with the triangle on the pin-1 corner of the ZIF socket.

- 2 Place the processor module lightly in the ZIF socket and ensure that the processor module is positioned correctly.

 **CAUTION:** To avoid damage to the processor module, hold the screwdriver perpendicular to the processor module when turning the cam screw.

- 3 Tighten the ZIF socket by turning the cam screw clockwise to secure the processor module to the system board.

Postrequisites

- 1 Follow the instructions from step 2 to step 18 in "Replacing the System Board" on page 84.
- 2 Follow the instructions in "After Working Inside Your Computer" on page 13.

System Setup

Overview

Use the system setup to:

- Get information about the hardware installed in your computer, such as the amount of RAM, the size of the hard drive, and so on
- Change the system configuration information
- Set or change a user-selectable option, such as the user password, type of hard drive installed, enabling or disabling base devices, and so on

CAUTION: Unless you are an expert computer user, do not change the settings for this program. Certain changes can make your computer work incorrectly.



NOTE: Before you change system setup, it is recommended that you write down the system setup screen information for future reference.

Entering System Setup

- 1 Turn on (or restart) your computer.
- 2 During POST, when the DELL logo is displayed, watch for the F2 prompt to appear and then press <F2> immediately.



NOTE: The F2 prompt indicates that the keyboard has initialized. This prompt can appear very quickly, so you must watch for it, and then press <F2>. If you press <F2> before the F2 prompt, this keystroke is lost. If you wait too long and the operating system logo appears, continue to wait until you see the Microsoft Windows desktop. Then, turn off your computer and try again. See "Turn Off Your Computer and Connected Devices" on page 11.

System Setup Screens

The system setup screen displays current or changeable configuration information for your computer. Information on the screen is divided into three areas: the **setup item**, active **help screen**, and **key functions**.

Setup Item — This field appears on the left side of the system setup window. The field is a scrollable list containing features that define the configuration of your computer, including installed hardware, power conservation, and security features. Scroll up and down the list with the up- and down-arrow keys. As an option is highlighted, the **Help Screen** displays more information about that option and available settings.

Help Screen — This field appears on the right side of the system setup window and contains information about each option listed in the **Setup Item**. In this field you can view information about your computer and make changes to your current settings. Press the up- and down-arrow keys to highlight an option. Press <Enter> to make that selection active and return to the **Setup Item**.

NOTE: Not all settings listed in the **Setup Item** are changeable.

Key Functions — This field appears below the **Help Screen** and lists keys and their functions within the active system setup field.

System Setup Options



NOTE: Depending on your computer and installed devices, the items listed in this section may not appear, or may not appear exactly as listed.

Main

System Time (hh:mm:ss)	Displays the system time.
System Date (mm/dd/yy)	Displays the system date.
BIOS Version	Displays the BIOS version.
Product Name	Displays the product name.
Service Tag	Displays the service tag of your computer.
Asset Tag	Displays the asset tag of the computer.
CPU Type	Displays the type of processor installed.
CPU Speed	Displays the speed of the processor.
CPU ID	Displays the processor identification code.
CPU Cache	
L1 Cache	Displays the processor L1 cache size.

L2 Cache	Displays the processor L2 cache size.
L3 Cache	Displays the processor L3 cache size.
Integrated Graphics	Displays the integrated graphics.
Discrete Graphics 1	Displays the discrete graphics.
Fixed HDD	Displays the device name and size.
SATA ODD	Displays the device name and size.
mSATA Device	Displays the device name and size.
AC Adapter Type	Displays the device name and type.
Total Memory	Displays the total memory available in your computer.
Memory Bank 0	Displays the memory size installed in DIMM 0.
Memory Bank 1	Displays the memory size installed in DIMM 1.

Advanced

Intel(R)SpeedStep	Allows you to enable or disable the Intel SpeedStep technology. Disabling this feature may improve performance, but will greatly reduce battery life.
Virtualization	Allows you to enable or disable the Intel Virtualization technology.
Integrated NIC	Allows you to enable or disable the on-board LAN controller. <ul style="list-style-type: none"> • Disabled: Internal LAN is disabled and is not visible to the operating system. • Enabled: Internal LAN is enabled.

USB Emulation

Allows you to enable or disable the USB emulation feature. This feature defines how the BIOS, in the absence of a USB-aware operating system, handles USB devices. USB emulation is always enabled during POST.

NOTE: You cannot boot any type of USB device (floppy, hard drive, or memory key) when this option is off.

USB Powershare

Allows you to charge USB devices when the computer is turned off or in standby mode.

- AC Only: Charge USB devices when connected to AC adapter only.
- AC and Battery: Charge USB devices when connected to AC adapter and when the computer is running on battery.
- Disabled: Disables USB Powershare.

USB Wake Support

Allows you to enable USB devices to wake the computer from standby or to disable the USB wake support feature.

NOTE: If USB Powershare is enabled, a device connected to the USB Powershare connector may not wake the computer.

SATA Operation

Allows you to configure the operating mode of the integrated SATA hard drive controller.

- ATA: SATA is configured for ATA mode.
- AHCI: SATA is configured for AHCI mode.

Adapter Warnings

Allows you to choose if the computer should display warning messages when you use certain power adapters. The computer displays these messages if you attempt to use a power adapter that has too little capacity for your configuration.

- Disabled: BIOS will not detect unsupported AC adapters and will not display any message on the screen.
- Enabled: BIOS will detect unsupported AC adapters and display an error on the screen.

Function Key Behavior

If enabled, you can use the multimedia keys directly without using the function key combination.

Battery Health

Displays the battery health of your computer.

Miscellaneous Devices

External USB Ports

Allows you to enable or disable external USB ports.

USB debug

This feature supports only USB 3.0 devices.

Performance Option

CPU Turbo Mode

Allows you to enable or disable the Intel CPU turbo mode performance option.

Overclocking Features

Allows you to enable or disable the global overclocking feature.

- Disabled: The overclocking feature is disabled.
- Enabled: Displays additional overclocking options.

Wireless

Bluetooth

Allows you to enable or disable the internal Bluetooth device.

Wireless Network	Allows you to enable or disable the internal wireless device.
DMC	Allows you to enable or disable the internal DMC device

Security

Admin Password	Displays the admin account password.
System Password	Displays the system password.
Admin Password	Allows you to set the admin password.
System Password	Allows you to set the system password.
Password Change	Displays whether you have access to change passwords.
Computrace(R)	Allows you to enable or disable Computrace security feature.

Boot

Boot Device Priority: Use F5 or F6 keys to change the boot device priority. You can choose from:

- Hard Drive
 - CD/DVD/CD-RW Drive
 - Network
-

Exit Menu

Exit Saving Changes	Allows you to exit System Setup and save your changes to CMOS.
Save Change Without Exit	Allows you remain in System Setup and save your changes to CMOS.
Exit Discarding Changes	Allows you to exit System Setup and load previous values from CMOS for all Setup items.
Load Optimal Defaults	Allows you to load default values for all Setup items.
Discard Changes	Allows you to load previous values from CMOS for all Setup items.

Boot Sequence

This feature allows you to change the boot sequence for devices.

Boot Options

- **Hard Drive** — The computer attempts to boot from the primary hard drive. If no operating system is on the drive, the computer generates an error message.
- **CD/DVD/CD-RW Drive** — The computer attempts to boot from the optical drive. If no disc is in the drive, or if the disc is not bootable, the computer generates an error message.
- **Network** — The computer attempts to boot from the network. If no operating system is found on the network, the computer generates an error message.

Changing Boot Sequence for the Current Boot

You can use this feature to change the current boot sequence, for example, to boot from the optical drive to run Dell Diagnostics from the *Drivers and Utilities* disc. The previous boot sequence is restored at the next boot.

- 1 If you are booting from a USB device, connect the USB device to a USB connector.
- 2 Turn on (or restart) your computer.
- 3 When **F2 Setup**, **F12 Boot Options** appears in the lower-right corner of the screen, press <F12>.



NOTE: If you wait too long and the operating system logo appears, continue to wait until you see the Microsoft Windows desktop. Then shut down your computer and try again.

The **Boot Device Menu** appears, listing all available boot devices.

- 4 On the **Boot Device Menu** choose the device you want to boot from and press <Enter>.

Changing Boot Sequence for Future Boots

- 1 Enter system setup. See "Entering System Setup" on page 97.
- 2 Use the arrow keys to highlight the **Boot** menu option and press <Enter> to access the menu.
 **NOTE:** Write down your current boot sequence in case you want to restore it.
- 3 Press the up- and down-arrow keys to move through the list of devices.
- 4 Press plus (F5) or minus (F6) to change the boot priority of the device.

Flashing the BIOS

The BIOS may require flashing when an update is available or when replacing the system board. To flash the BIOS:

- 1 Turn on the computer.
- 2 Go to support.dell.com/support/downloads.
- 3 Locate the BIOS update file for your computer:



NOTE: The Service Tag for your computer is located on a label at the bottom of your computer. For more information, see the Quick Start Guide that shipped with your computer.

If you have your computer's Service Tag or Express Service Code:

- a Enter your computer's Service Tag or Express Service Code in the **Service Tag or Express Service Code** field.
- b Click **Submit** and proceed to step 4.

If you do not have your computer's Service Tag or Express Service Code:

- a Select one of the following options:
 - **Automatically detect my Service Tag for me**
 - **Choose from My Products and Services List**
 - **Choose from a list of all Dell products**
- b Click **Continue** and follow the instructions on the screen.
- 4 A list of results appears on the screen. Click **BIOS**.
- 5 Click **Download File** to download the latest BIOS file.
- 6 In the **Please select your download method below** window, click **For Single File Download via Browser**, and then click **Download Now**.
- 7 In the **Save As** window, select an appropriate location to download the file on your computer.
- 8 If the **Download Complete** window appears, click **Close**.

- 9 Navigate to the folder where you downloaded the BIOS update file. The file icon appears in the folder and is titled the same as the downloaded BIOS update file.
- 10 Double-click the BIOS update file icon and follow the instructions that appear on the screen.